

Data Sheet



Article number: 3918049010227

Description: Worm gear with st. steel hollow shaft
VF 49 EP-A-10- 71B5

Measures

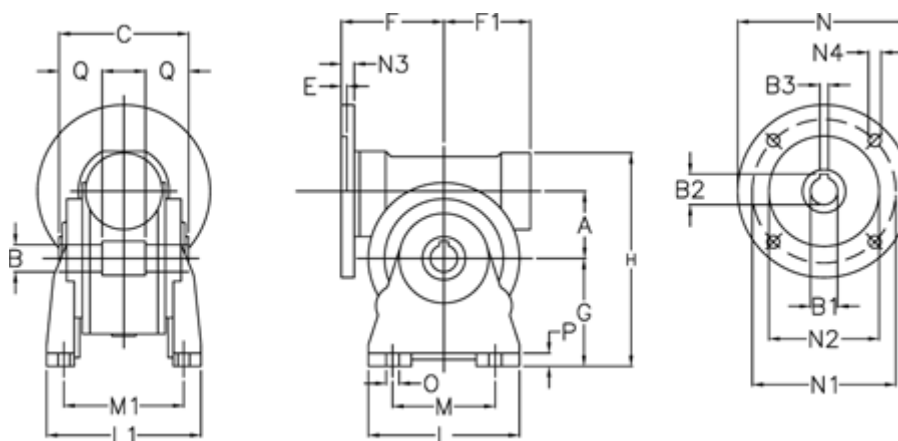

a	= 49.5	F1	= 63	N1	= 130
B	= 25	g	= 82	N2	= 110
B1 E7	= 14	H	= 162	N3	= 10.5
B2	= 16.3	L	= 110	N4	= 9.5
B3 H9	= 5	L1	= 124.0	O	= 8.5
C	= 82	m	= 63	P	= 12
E	= 3.0	M1	= 98.5	Q	= 22.5
F	= 70	N	= 160		